

Article number: 2310431133

Description: E+G Levelling elements
LX.40-SW17-SST-M8X22

Measures

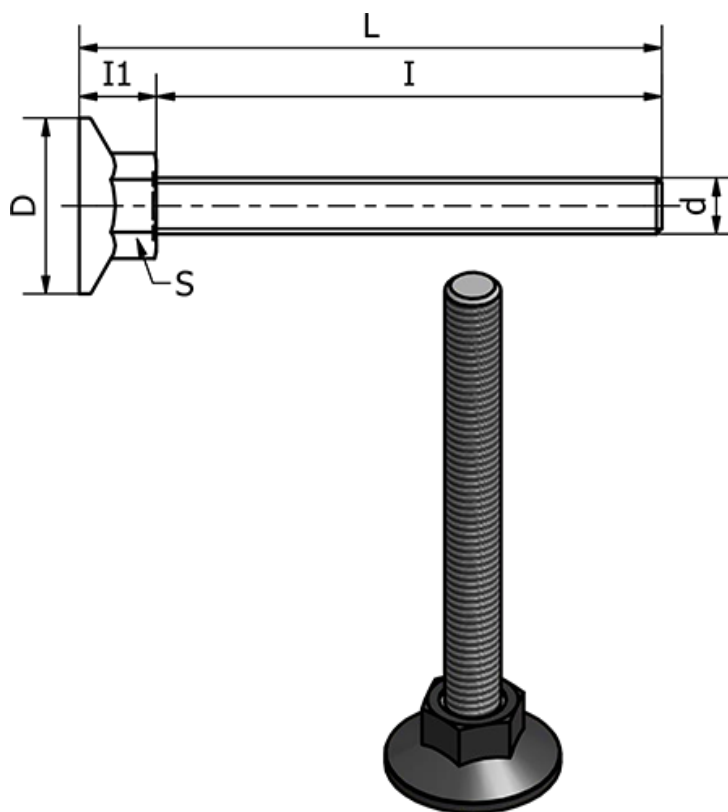

d = M8

D = 40

I = 22

I1 = 13

L = 32.5

S = 17

Static load in (N) = 2500

Type = AISI 304 Rustfast

Weight (g) = -